



Scan QR code to focus upon Sail Intelligent Elevator 3D Cartoon



Scan QR code to focus upon Sail Intelligent Elevator Advertisement



Scan QR code to focus upon Sail Intelligent Elevator Website

 Service hotline **400-8866-350**

SAIL | Sail Intelligent Elevator(Suzhou) Co.,Ltd.

Address: no.999, Badu Lingang Development Zone (Fenglin Bay) Zhenze Town,
Wujiang District, Suzhou City, jiangsu province
Tel : 0512-63825632 Fax : 0512-63825700
Http : //www.szsail.com E-mail : //sail@szsail.com

It is an ordinary information publication. We keep the right of alter the product design and description at any time. If there is any dispute out of the literal meaning of any product description, use or quality; the description and alteration of any sales contract, our company will not bear any responsibilities there-from.
Because of the restriction of the printing technology if there is any slight difference between the actually machining color and that from this pamphlet, please take the actual material and color sample as the criterion.
Printed in June 2017

STM 盛隆传媒 0573-88133500 13511315781

SAIL

HIGH TECHNOLOGY
FULFILLS A BRIGHT FUTURE

PASSENGER **ELEVATOR** SERIES

Sail Intelligent Elevator(Suzhou) Co.,Ltd.





Focus upon **intellectual** elevators
Lead new concept
of future elevators

Intellectual times, summit conference.
Wisdom appears invisible and peaceful.
Let' s hug intellectual manufacture and gather together
innovative cohesion.
The building is endowed with unique charm because
of magical & flexible space.
Let' s wisely compose a bright future of intellectual
made in China.

Intellectual technology

Wireless five-party conversation

Under the conditions of elevator's trapping passengers or other necessary matters, personnel in elevator car can dial designated telephone number through five-party intercom calling button. Designated telephone number can also be incoming call. IOT-WL210DBW answers automatically. It dialogues with personnel inside elevator car.

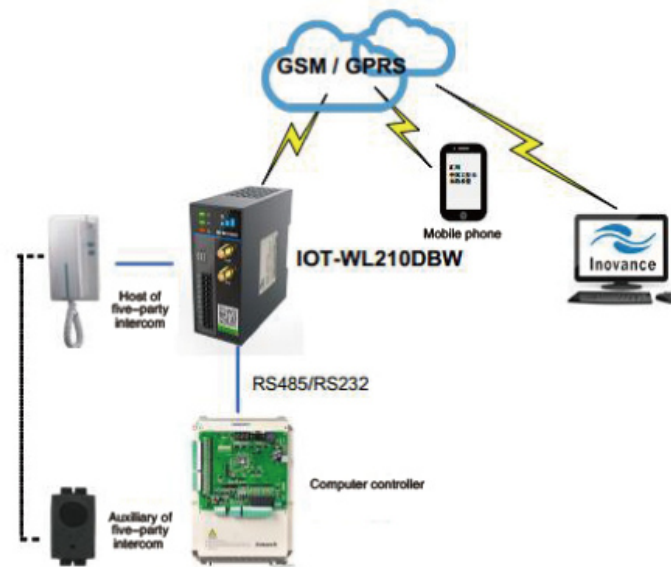

ID/IC card (Identification) (optional)

The ID/IC card exerts control over the use of elevator, which allows only the ID/IC card bearers to use the elevator, greatly increases the safety of building management, removing the concerns of the residents.



Excavate big data, create intellectual mode

In the times of big data, users' feedback data relates to users' requirements. Business can truly and comprehensively know the users' true demands through collecting and analyzing the users' feedback data. Intellectual analysis & monitor platform is based upon transaction data. It utilizes the advanced big data analysis model to have precision positioning of new customers. It stores and converts the problems. It helps the enterprises to effectively diagnose the business problems. It enhances the enterprises' fine operation degree. It fulfills intellectual enterprise operation.

Intellectual technology

YI 1080P intellectual camera

24-hour full-time monitor on-line solution



- 1080P high definition
- 112° wide angle
- Two-way voice
- Infrared night vision
- Sound detection
- Cloud storage

Internet technology

Adopts advanced sensor technology to collect real-time operation data of elevator, makes data analysis, modeling through micro processor, adopts GPRS+GSM communication pattern to transmit data to monitoring center, being comprehensive elevator management platform realizing elevator malfunction fault alarm, rescue, daily management, quality evaluation, risk prevention, risk evaluation, bench marking system and energy technology.

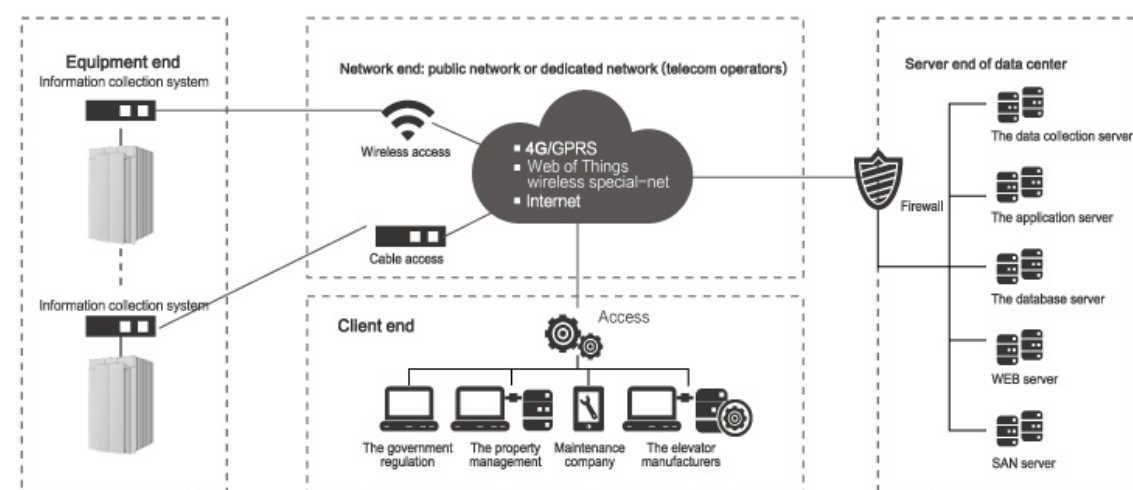

Monarch original control cabinet

Monarch original control cabinet is light, handy and sensitive with smooth operation. It gives a full play of environment protection, energy-saving and low carbon ideas. It applies 32-digit double-CPU with inter-monitor of master / slave CPU. It enhances the data processing speed to a greater degree. System sets highly intellectual micro-computer module. It executes the more secure, accurate and effective management control to elevator operation.

Permanent magnet synchronous and gearless traction machine

Advanced permanent magnet synchronous and gearless traction technology and digital variable frequency technology let passenger elevator to execute real-time adjustment to motor current. It can greatly reduce average running current. It thus lowers down the power consumption.



Top grade door machine system

Fully computerized VVVF closed-loop control mode fulfills the smooth operation. It needs no position switch. Internal self-tuning function records various floor door widths by memory. It ensures the accurate and proper door-opening.

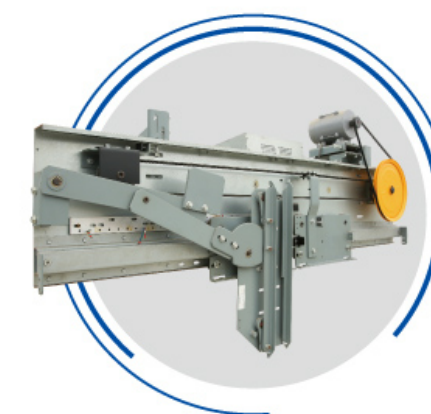

Small machine room passenger elevator

Energy saving

Sail Intelligent small machine room passenger elevator use permanent magnetic synchronous gearless traction machine, featuring high effective and energy saving. It saves by 33% energy than the gear traction machine for the same capacity. The best design comprising special designed control cabinet with small size and the most advanced IGBT with lower loss makes the layout of the machine room perfect.

Compact design

Sail Intelligent small machine room passenger elevator is a kind of elevator with new concept, which is for improving the construction value. The area of machine room can be reduced by more than 40% than traditional elevator, so it saved construction space and increased useful space.



20~30%

Permanent magnet synchronous and gearless traction machine
It reduces power consumption

80%

Energy feedback regeneration technology
Recovery & utilization rate

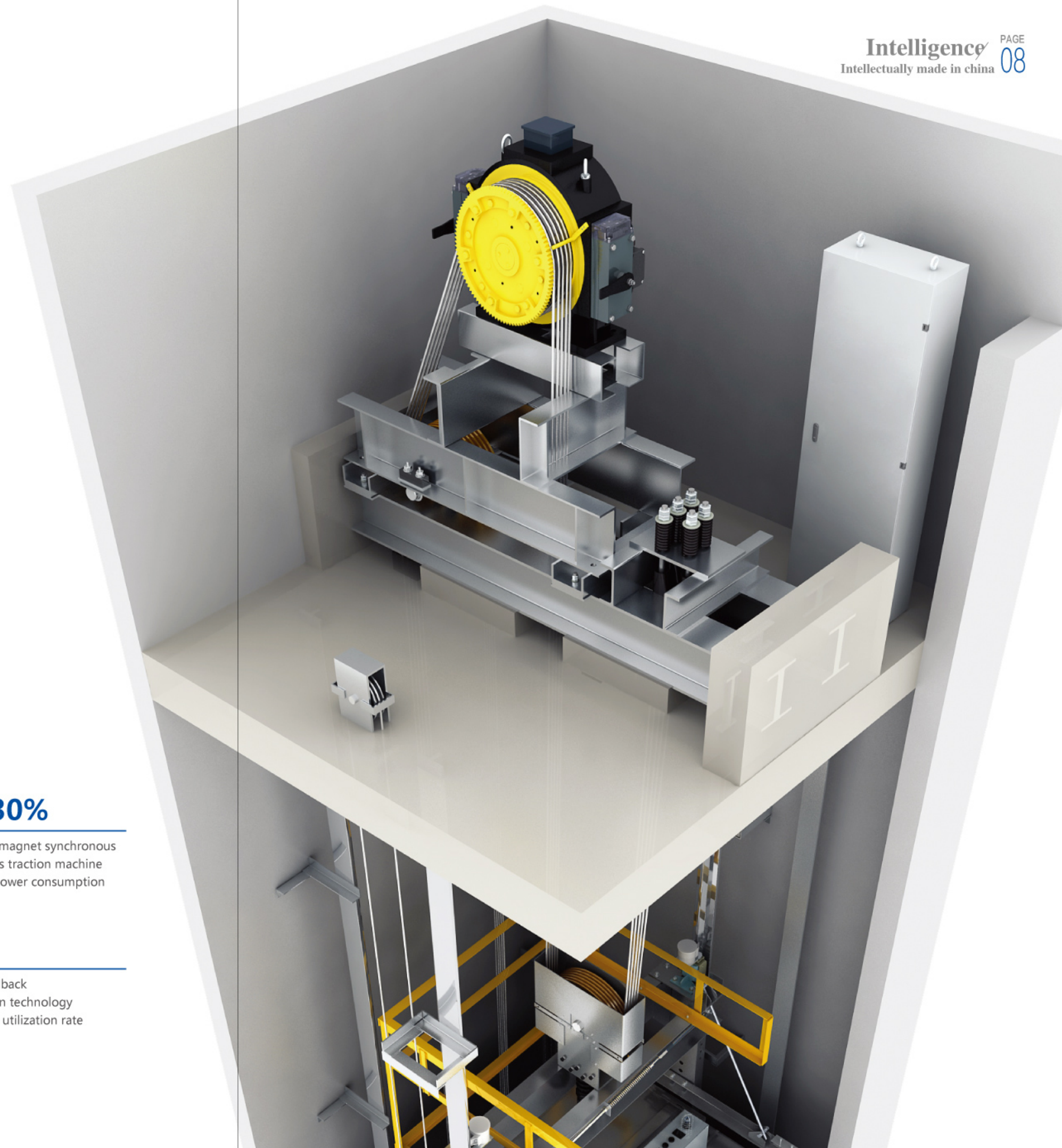

Machine roomless passenger elevator

It saves energy and space.

Sail Intelligent machine room-less passenger elevator knows very well of environment protection concept. It saves energy and reduces consumption. It enhances design freedom. Compared with geared elevator with same load rating, it saves over 33% of energy. Sail Intelligent machine room-less passenger elevator breaks through a must of machine room. It provides limited space in modern building with perfect creativeness.



Efficient space



Fashion design



Stable and reliable operation



Energy-saving operation

Low noise, tiny vibration

Comprising the best components, the reasonable structure design and the high technology of vibration reducing and noise controlling can disperse and counteract the irregular vibration of the car, which make car run quietly.



Standard configuration



SA-KT001

Standard

Ceiling : Stainless steel framework, acrylic roof and lamp decoration
Car wall : Hairline stainless steel
Handrail: None
Floor : PVC



Scan the QR code to know more about the lift car in the 360-degree manner.

Car operation panel



SA-C001
Standard



SA-CW001
Optional

Ceiling



SA-D001

Hairline stainless steel, down lamp decoration

Landing door

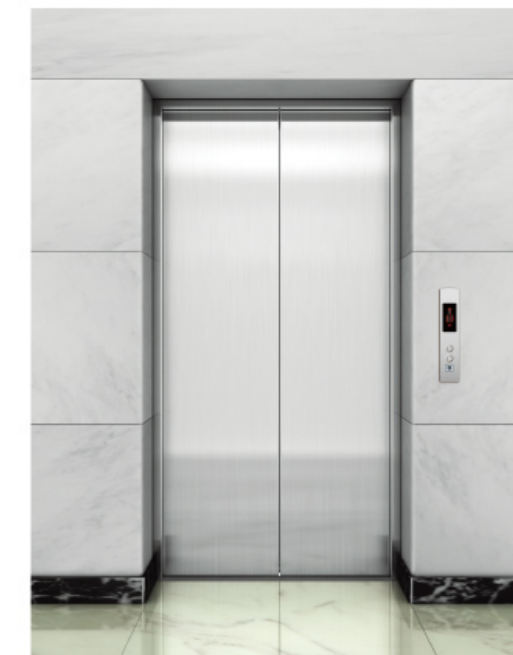

SA-M001 Standard

Landing door: Hairline stainless steel
Jamb: Hairline stainless steel

The hall door of the first floor is made of hairline stainless steel, and other hall doors are made of coating steel plates.

Car decoration



SA-KT002

Optional

Ceiling: Central image arch, stainless steel
bottom panel is supplemented with soft lighting
design of down lamp on both sides
Car wall: Mirror, etched, hairline
Handrail: Stainless steel tube handrail
Floor: PVC



SA-KT003

Optional

Ceiling : Stainless steel frame,
central image arch
Car wall : Mirror, etched, hairline
Handrail: Stainless steel tube handrail
Floor : PVC

Car decoration



Car decoration



SA-KT006

Optional

Car wall: Titanium gold, mirror, etched, hairline, vibration

Ceiling: Wide vaulted white top panel for soft illumination design

Handrail: Solid wood round and Titanium gold

Floor: PVC



Scan the QR code to know more about the lift car in the 360-degree manner



Scan the QR code to know more about the lift car in the 360-degree manner

SA-KT007

Optional

Car wall: Titanium gold, mirror, etched, hairline, vibration

Ceiling: Stainless steel mirror curve and white transparent board with aluminium alloy frame

Handrail: Titanium gold stainless steel handrails three combination

Floor: PVC



Stretcher elevator

Human-centered design, rich functions

It satisfies the needs of emergency patients' delivery. It applies human-centered design and is equipped with a full set of top equipments. It is smooth and comfortable in running. It has bright and broad car. It not only has ordinary passenger-transport functions, furthermore, it can contain stretch. Meanwhile, it is convenient for the people to carry large furniture.

Safe, prompt and convenient custom-made elevators

Sail Intelligent stretcher elevator is custom-made for your building. It applies high strength section materials to make elevator cars. It can bear heavy stretchers. It can easily and smoothly deliver vast patients and large goods. It effectively protects the security of both passengers and the goods.

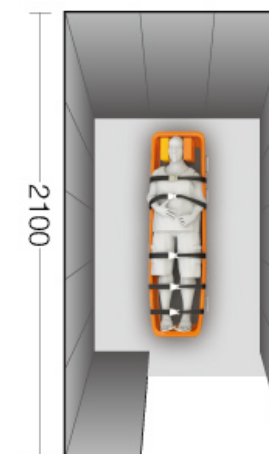

Depth reaches 2100mm.
It is convenient for direct entry / exit of rescue stretcher.

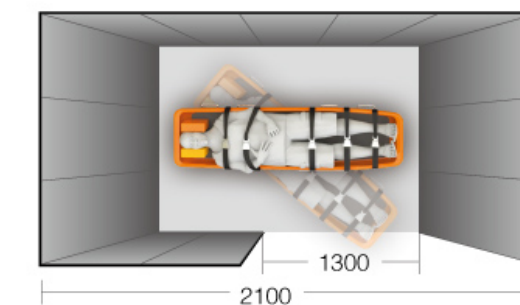

Observation elevator



Low Noise



Low Vibration



High Stable



Effective



Superior car wall

It applies highly secure laminated glass with fine transparency. Passengers can busy and beautiful city scene through transparent car wall. Lamination layer within laminated glass has anti-radiation function. It can buffer sonic vibration of sound. It thus has sound insulation effect. Large-area car wall glass design is smooth in lines. It beautifies car outlines, adds more beauty to the building.

Glass fiber reinforced plastics structure

It perfectly displays compact space and overall attraction. It can execute different construction layout design. It is prompt and convenient. Round, half-round, square etc. are available for your free choices.

Graphic blue line part shows observation face transparent glass.

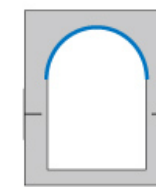

Semi-circular shaped

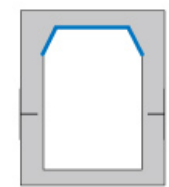

Cutting-angle-type

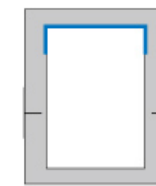

Square shaped

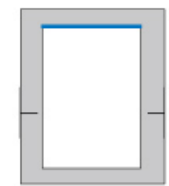

Panoramic

Car decoration

SA-GT001

Standard

Car cover: Hairline stainless steel
 Observation wall: laminated safety glass
 Decoration ceiling: Steel plate baked enamel framework, acrylic arch top plate
 Car wall: Hairline stainless steel
 Handrail: Stainless steel tube
 Floor: PVC



SA-GT003

Optional

Car cover: Steel plate baked enamel, lighting decoration
 Observation wall: Laminated safety glass
 Decoration ceiling: Steel plate baked enamel frame, acrylic top-panel, down lamp
 Car wall: Hairline stainless steel
 Handrail: stainless steel tube
 Floor: PVC

SA-GT002

Optional

Car cover: Steel plate baked enamel
 Observation wall: 180°round laminated safety glass, glass thickness 6+6
 Decoration ceiling: Steel plate baked enamel framework, acrylic arch top plate
 Car wall: Hairline stainless steel
 Handrail: Stainless steel tube
 Floor: PVC



Car decoration



SA-GT004

Optional

- Car cover: Steel plate baked enamel, lighting decoration
- Observation wall: Laminated safety glass
- Decoration ceiling: Hairline stainless steel, acrylic lighting decoration
- Car wall: Hairline stainless steel
- Handrail: Stainless steel tube
- Floor: PVC



SA-GT006

Optional

- Car cover: Painted stainless steel plate, sheathing of titanium gold stainless steel
- Observation wall: Laminated safety glass (6+6)
- Decoration ceiling: Painted stainless steel plate, acrylic lampshade
- Car wall: Hairline stainless steel
- Handrail: Stainless steel duplex handrail
- Floor: PVC

SA-GT005

Optional

- Car cover: Steel plate baked enamel
- Observation wall: Laminated safety glass (6+6)
- Decoration ceiling: Steel plate baked enamel frame, acrylic lighting decoration
- Car wall: Hairline stainless steel
- Handrail: Stainless steel triple handrail
- Floor: PVC





Hospital elevator



Special operation panel for the disabled(Optional)

When elevator makes leveling and waits for passenger, if command register in operation panel for disabled is available in the floor, it keeps longer opening time. (Usually it lasts for about 30 second. It can be changed through parameter adjustment.) If pressing "door-opening button" in operation panel for disabled, it keeps same door-opening time.



Anion car technology

It firstly uses "natural oxygen bar" car technology. Air anion is like vitamin in food. It is vital to human life activities. It adds oxygen anion in the air, improves air quality in the car. It is more beneficial for patients to travel the elevator.

UV ray sterilizer

As use people in hospital elevator are complex, it installs UV sterilizer in elevator car. With no load in elevator, it regularly and automatically starts / stops UV device. It carries out UV sterilization. UV ray kills virus and bacteria. It removes dust, cleans dirt. It eliminates smoke and odor etc. It accords with basic requirements in medical treatment institutes.

Car decoration



SA-HT001

Standard

Ceiling: Paint steel, fluorescent lighting ,
tube lamp (integration)
Car wall: Hairline stainless steel
Handrail: Double flat stainless steel
Floor: PVC



SA-HT002

Optional

Ceiling: Paint steel, LED lighting
Car wall: Hairline stainless steel
Handrail: Double flat stainless steel
Floor: PVC

Car operation panel

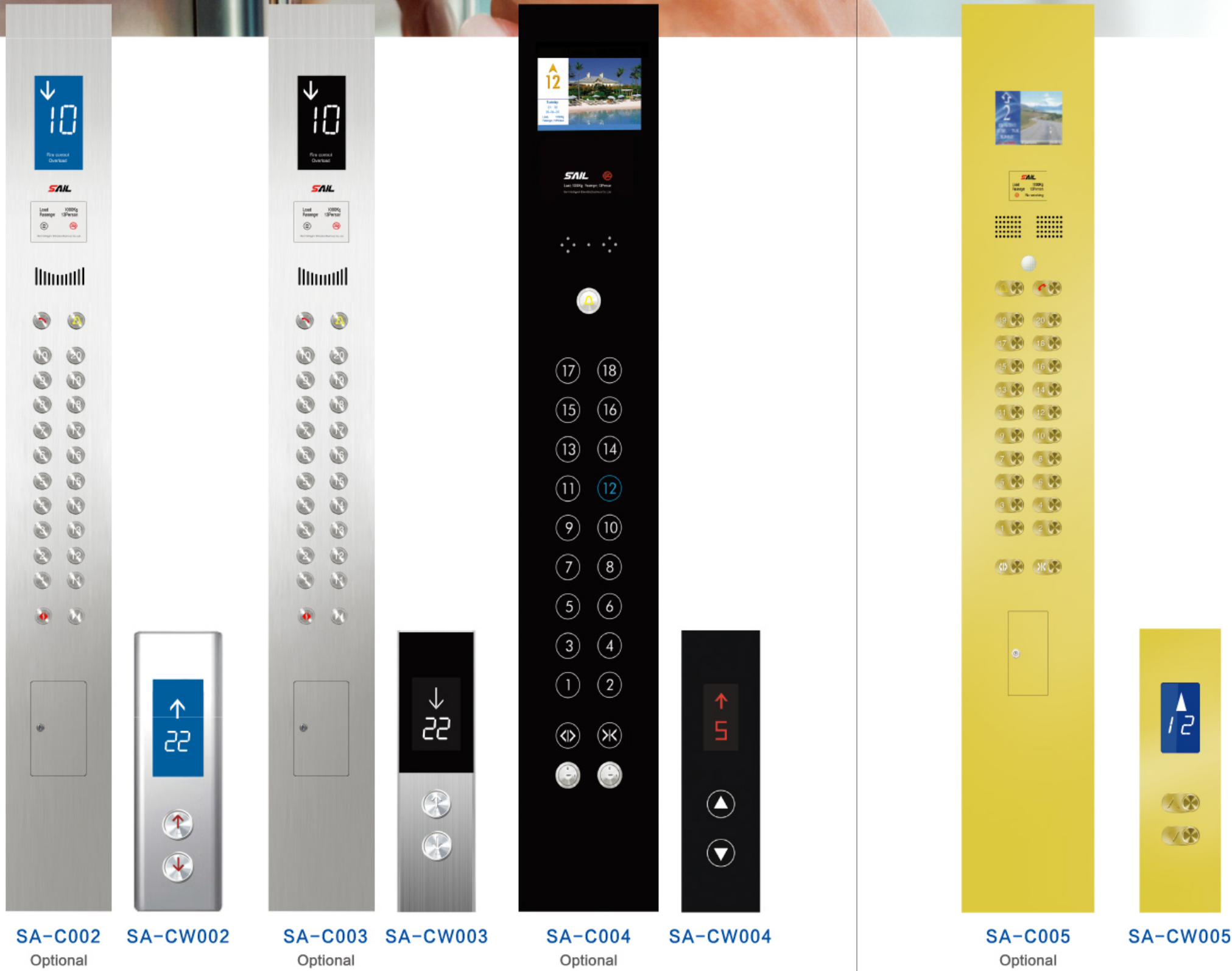

Display of calling box

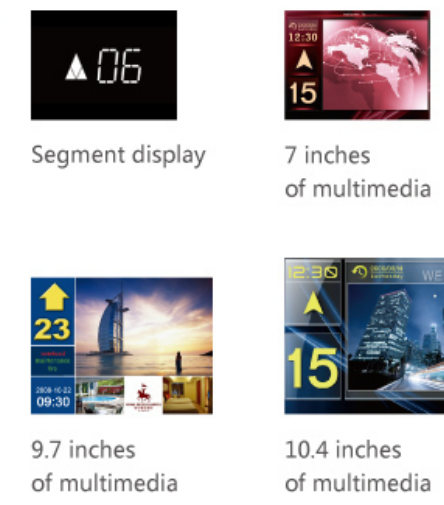

Optional of calling box



Press-button flash color

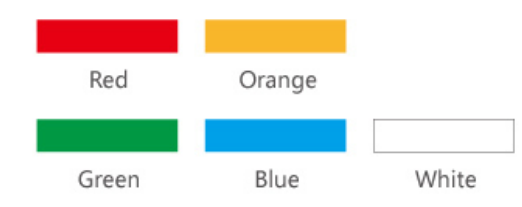

Because of restrictions in aspect of printing craft and technology, there will be slight difference between colors in this catalogue, the final model selection can be decided according to the actual material and color specimen.

Landing door series



SA-M002 Small door
Landing door: Mirror, etched, hairline
Jamp: Hairline stainless steel

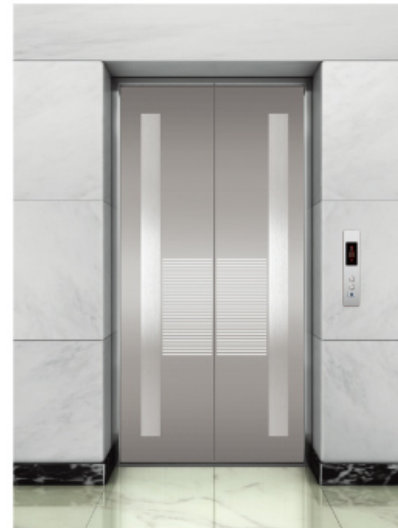

SA-M003 Small door
Landing door: Mirror, etched, hairline
Jamp: Hairline stainless steel



SA-M004 Small door
Landing door: Mirror, etched, hairline, vibration
Jamp: Hairline stainless steel



SA-M005 Small door
Landing door: Mirror, etched, hairline, vibration
Jamp: Hairline stainless steel

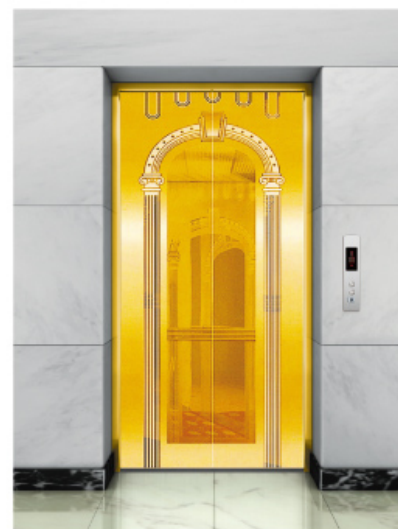

SA-M006 Small door
Landing door: Titanium gold, mirror, etched, hairline, vibration
Jamp: Titanium gold stainless steel

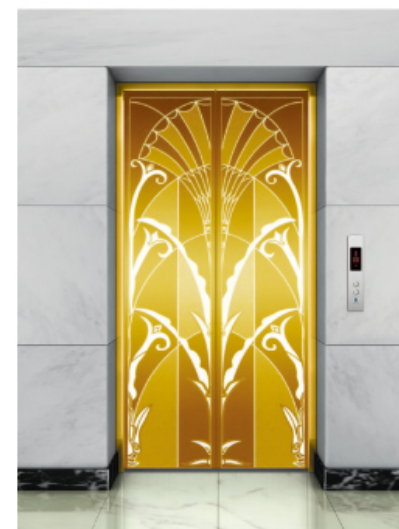

SA-M007 Small door
Landing door: Mirror, etched, hairline
Jamp: Titanium gold stainless steel

Handrail series

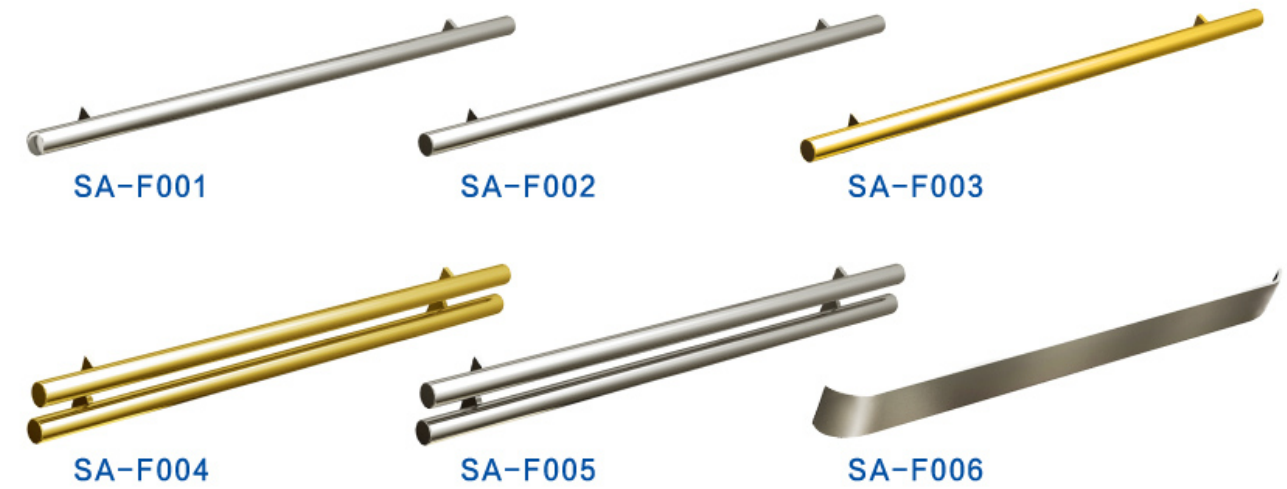

Ceiling series



SA-D002 Optional
Stainless steel frame, acrylic arch, LED lamps on both sides



SA-D003 Optional
Stainless steel hairline frame, acrylic lighting decoration, down lamp



SA-D004 Optional
Stainless steel hairline frame, acrylic light-emitting panel, down lamp

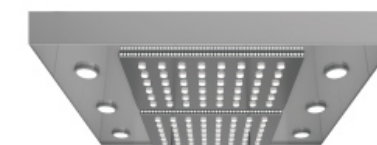

SA-D005 Optional
Multi-ply reflection board with soft lighting design of LED lights on both sides



SA-D006 Optional
Integrated ceiling
Mirror stainless steel, acrylic lighting decoration, LED lamps on both sides



SA-D007 Optional
Integrated ceiling
Mirror stainless steel frame, LED lamp

Function table

S-Standard O-Optional

Travel function	
S	VVVF drive Motor rotating speed can be precisely adjusted to get smooth speed curve in lift start, travel and stop and gain the sound comfort.
S	VVVF door operator Motor rotating speed can be precisely adjusted to get the more gentle and sensitive door machine start / stop.
S	Independent running The lift can not respond to outer calling, but only respond to the command inside the car through the action switch.
S	Automatic pass without stop When the car is crowded with the passengers or the load is close to preset value, the car will automatically pass the calling landing in order to keep maximum travel efficiency.
S	Automatically adjust door opening time Door-open time can be automatically adjusted according to the difference between landing calling or car calling.
S	Reopen with hall call In the door shutting process, press reopen with hall call button can restart the door.
S	Express door closing When the lift stops and opens the door, press door-shut button, the door will be closed immediately.
S	Car stops and door open The lift decelerated and levels, the door only opens after the lift comes to a complete stop.
S	Car arrival gong Arrival going in the car top announces that the passengers arrive.
S	Command register cancel If you press the wrong floor command button in the car, twice continuous pressing of the same button can cancel the registered command.
O	Anti-nuisance In the light lift load, when three more commands appear, in order to avoid the unnecessary parking, all the registered callings in the car will be cancelled.
O	Open the door in advance When the lift decelerates and enters into door open zone, it automatically opens the door to enhance the travel efficiency.
O	Direct parking It completely accords with distance principle with no crawling in the leveling. It greatly enhances the travel efficiency.
O	Group control function When three or more same model lift groups are controlled in use, the lift group can automatically choose the most appropriate response. It avoids the repeated lift parking, reduces the passengers' waiting time and increases the travel efficiency.
O	Duplex control Two sets of same model lifts can unanimously respond the calling signal through the computer dispatch. In this way, it reduces the passengers' waiting time to the greatest extent and enhances the travel efficiency as well.
O	On-duty peak service Within the preset on-duty time, upward transport from the home landing is extremely busy. The lifts are continuously dispatched to the home landing in order to satisfy on-duty peak service.
O	Off-duty peak service Within the preset off-duty period, the lifts are continuously dispatched to top floor in order to satisfy off-duty peak service.
O	Door open time extending Press special button in the car, the lift door keeps open for certain period of time.

Man-machine interface	
S	Micro-touch button for car call and hall call Novel micro-touch button is used for operation panel command button in the car and landing calling button.
S	Floor and direction indicator inside car The car shows the lift floor location and current travel direction.
S	Floor and direction indicator in hall The landing shows the lift floor location and current travel direction.
O	Voice announcer When the lift normally arrives, voice announcer informs the passengers about the relevant information.
O	Car assistant operation box It is used in the large loading weight lifts or the lifts with crowded passengers so that more and more passengers can use the car.
O	Operation box for the handicapped It is convenient for the wheelchair passengers and those who have vision problems.
O	Intelligent calling service The car command or hoist-way calling can be locked or connected through special Intelligent Input.
O	IC card control function All (partial) landings can only input car commands through IC Card after the authorization.

Monitor function	
O	Remote monitor The lift long-distance monitor and control can be fulfilled through modem and telephone. It is convenient for the factories and service units to timely know the travel conditions of every lift and promptly take the corresponding measures.
O	Remote control The lift can have independent travel according to the specific requirements through operation monitor screen (optional).
O	Camera function in the car The camera is installed in the car to monitor the car conditions.

Safety function	
S	Light curtains protection In the door open and shut period, infrared light that covers the whole door height is used to probe the door protection device of both the passengers and objects.
S	Designated stop If the lift can not open the door in the destination floor out of some reason, the lift will close the door and travel to the next designated floor.
S	Overload holding stop When the car is overload, the buzzer rings and stops the lift in the same floor.
S	Anti-stall timer protection The lift stops operation due to slippery traction wire rope.
S	Start protection control If the lift does not leave door zone within the designated time after it gets started, it will stop the operation.
S	Inspection operation When the lift enters into inspection operation, the car travels at inching running.
S	Fault self-diagnosis The controller can record 62 latest troubles so as to quickly remove the trouble and restore the lift operation.
S	Repeated door closing If the lift can not close the door due to certain obstacle or interference, the lift will reopen or re-shut the door until sundries are eliminated.
S	Up/down over-run and final limit protection The device can effectively prevent from the lift's surging to the top or knocking the bottom when it is out of control. It results in more safe and reliable lift travel.
S	Down over-speed protection device When the lift downs 1.2 times higher than the rated speed, this device will automatically cut off control mains, stop the motor running so as to stop lift down at over-speed. If the lift continues to down at over-speed, and the speed is 1.4 times higher than rated speed, safety tongs act to force the lift stop in order to ensure the safety.
S	Upward over-speed protection device When the lift up speed is 1.2 times higher than rated speed, the device will automatically decelerate or brake the lift.
S	Elevator cab prevents accidental movement When the elevator is in the open state, if there is accidental movement, the elevator cab can present the movement.

Emergency function	
S	Emergency car lighting Emergency car lighting automatically activated once power failure.
S	Inching running When the lift enters into emergency electric operation, the car travels at low speed inching running.
S	Five way intercom Communication amid car, car top, lift machine room, well pit and rescue duty room through walkie-talkie.
S	Bell In emergency conditions, if bell button above car operation panel is continuously pressed, electric bell rings on top of the car.
S	Fire emergency return If you start key switch in main landing or monitor screen, all the callings will be cancelled. The lift directly and immediately drives to the designated rescue landing and automatically opens the door.
O	Leveling when power failure In normal power failure, the chargeable battery supplies the lift power. The lift drives to the nearest landing.

Energy-saving function	
S	Car ventilation, light automatic shut off If there is no calling or command signal within the stipulated time, the car fan and lighting will be automatically closed in order to save the energy.
S	Remote shut-off The lift can be called to main landing (after finishing the service) through the key switch and automatically exists the service.

Small machine room passenger elevator construction sketch

Vertical view of well side

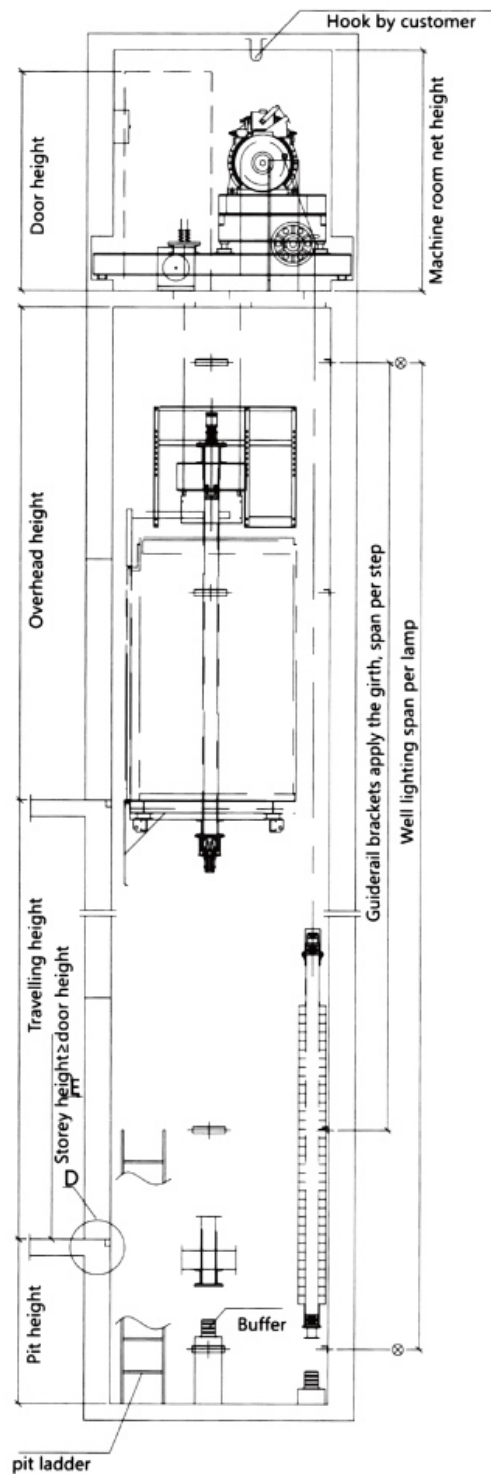

Machine room layout chart

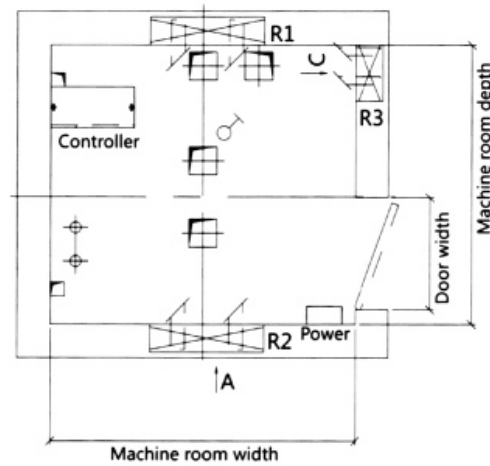

Hoistway plan layout

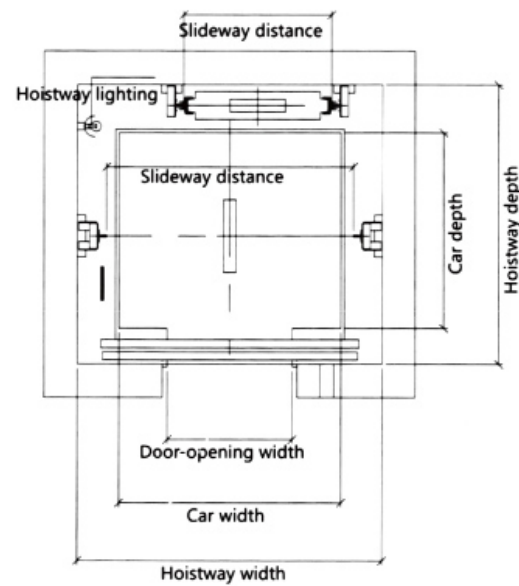

Small machine room passenger elevator construction specifications

Load	Speed	Car size			Door opening size		Hoistway size				Maximum landing	Maximum lifting height	Net height of machine room
		CW	CD	CH	OP	OPH	HW	HD	K	S			
450	1.00	1100	1100	2400	700	2100	1700	1700	≥4500	≥1500	≤12	≤55	≥2500
	≥4600								≥1600	≤24	≤85		
630	1.00	1400	1100	2400	800	2100	2000	1700	≥4500	≥1500	≤12	≤55	≥2500
	≥4600								≥1600	≤24	≤85		
800	1.00	1400	1350	2400	800	2100	2000	1950	≥4500	≥1500	≤12	≤55	≥2500
	≥4600								≥1600	≤24	≤85		
	≥4700								≥1700	≤32	≤100		
	≥5000								≥2000	≤40	≤110		
	≥5200								≥2200	≤48	≤140		
	≥5600								≥3500	≤52	≤150		
1000	1.00	1600	1400	2400	900	2100	2200	2000	≥4500	≥1500	≤12	≤55	≥2500
	≥4600								≥1600	≤24	≤85		
	≥4700								≥1700	≤32	≤100		
	≥5000								≥2000	≤40	≤110		
	≥5200								≥2200	≤48	≤140		
	≥5600								≥3500	≤52	≤150		
1150	1.00	1900	1400	2400	1100	2100	2500	2100	≥4500	≥1500	≤12	≤55	≥2500
	≥4600								≥1600	≤24	≤85		
	≥4700								≥1700	≤32	≤100		
	≥5000								≥2000	≤40	≤110		
	≥5200								≥2200	≤48	≤140		
	≥5600								≥3500	≤52	≤150		
1250	1.00	1900	1500	2400	1100	2100	2500	2200	≥4500	≥1500	≤12	≤55	≥2500
	≥4600								≥1600	≤24	≤85		
	≥4700								≥1700	≤32	≤100		
	≥5000								≥2000	≤40	≤110		
	≥5200								≥2200	≤48	≤140		
	≥5600								≥3500	≤52	≤150		
1350	1.00	1900	1600	2400	1100	2100	2500	2250	≥4500	≥1500	≤12	≤55	≥2500
	≥4600								≥1600	≤24	≤85		
	≥4700								≥1700	≤32	≤100		
	≥5000								≥2000	≤40	≤110		
	≥5200								≥2200	≤48	≤140		
	≥5600								≥3500	≤52	≤150		
1600	1.00	1900	1750	2400	1200	2100	2600	2400	≥4500	≥1500	≤12	≤55	≥2500
	≥4600								≥1600	≤24	≤85		
	≥4700								≥1700	≤32	≤100		
	≥5000								≥2000	≤40	≤110		
	≥5200								≥2200	≤48	≤140		
	≥5600								≥3500	≤52	≤150		

The schematic Drawing of Aekson Sanyo work is for reference only

Machine roomless passenger elevator construction sketch

Stretcher elevator construction sketch

Hoistway vertical section

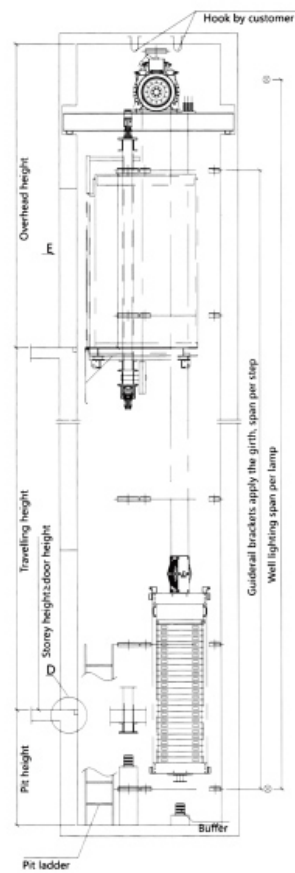

Overhead plan layout

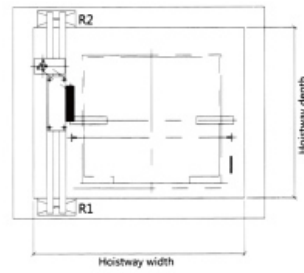

Hoistway plan layout

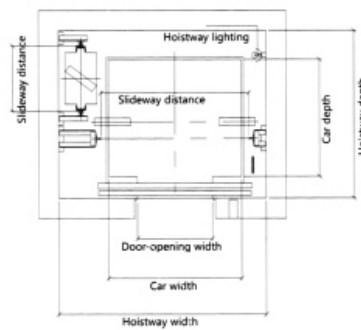

Vertical view of well side

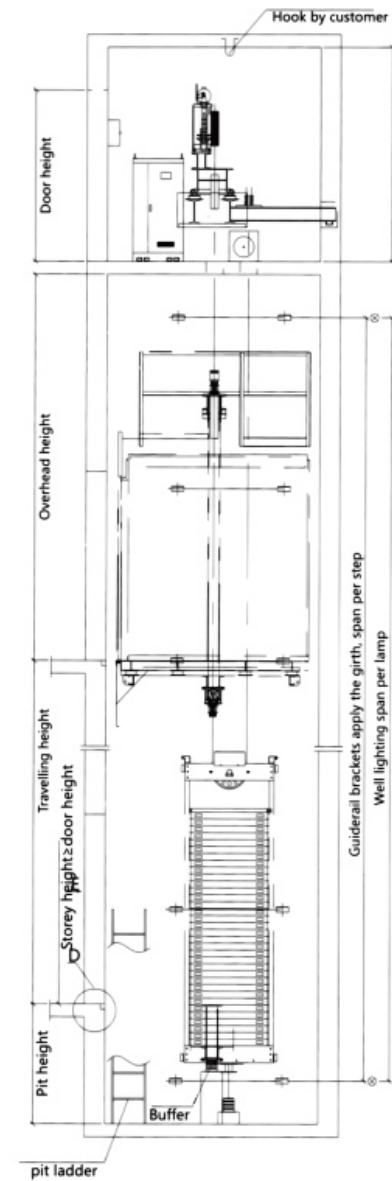

Machine room layout chart

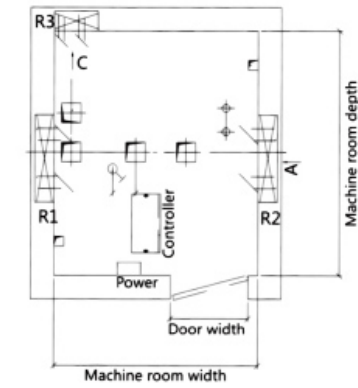

Hoistway plan layout

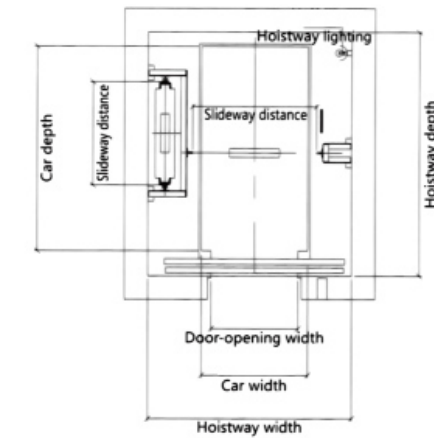

Machine roomless passenger elevator construction specifications

Load	Speed	Car size			Door opening size		Hoistway size				Maximum landing	Maximum lifting height
		CW	CD	CH	OP	OPH	HW	HD	K	S		
450	1.00	1100	1100	2400	700	2100	2000	1700	≥4200	≥1600	≤12	≤50
	1.50								≥4300	≥1700	≤16	≤60
	1.75								≥4500	≥2000	≤25	≤100
630	1.00	1400	1100	2400	800	2100	2300	1700	≥4200	≥1600	≤12	≤50
	1.50								≥4300	≥1700	≤16	≤60
	1.75								≥4600	≥2000	≤25	≤100
800	1.00	1400	1350	2400	800	2100	2300	2000	≥4200	≥1600	≤12	≤50
	1.50								≥4300	≥1700	≤16	≤60
	1.75								≥4500	≥2000	≤25	≤100
1000	1.00	1600	1400	2400	900	2100	2500	2000	≥4200	≥1600	≤12	≤50
	1.50								≥4300	≥1700	≤16	≤60
	1.75								≥4500	≥2000	≤25	≤100
1150	1.00	1900	1400	2400	1100	2100	2800	2000	≥4200	≥1600	≤12	≤50
	1.50								≥4300	≥1700	≤16	≤60
	1.75								≥4500	≥2000	≤25	≤100
1250	1.00	1900	1500	2400	1100	2100	2850	2000	≥4200	≥1600	≤12	≤50
	1.50								≥4300	≥1700	≤16	≤60
	1.75								≥4500	≥2000	≤25	≤100
1350	1.00	1900	1600	2400	1100	2100	2850	2400	≥4200	≥1600	≤12	≤50
	1.50								≥4300	≥1700	≤16	≤60
	1.75								≥4500	≥2000	≤25	≤100
1600	1.00	2000	1750	2400	1200	2100	2950	2500	≥4200	≥1600	≤12	≤50
	1.50								≥4300	≥1700	≤16	≤60
	1.75								≥4500	≥2000	≤25	≤100

The schematic Drawing of Aekson Sanyo work is for reference only

Stretcher elevator construction specifications

Load	Speed	Car size			Hoistway size				Maximum landing	Maximum lifting height
		CW	CD	OP	HW	HD	K	S		
1000	1	1100	2100	900	2100	2500	4500	1500	≤12	≤55
	1.5	1100	2100	900	2100	2500	4650	1600	≤24	≤85
	1.75	1100	2100	900	2100	2500	4700	1600	≤32	≤100
	2	1100	2100	900	2100	2500	4850	1750	≤40	≤110
	2.5	1100	2100	900	2100	2500	5050	1950	≤48	≤140

The schematic Drawing of Aekson Sanyo work is for reference only

Observation elevator construction sketch

Hospital elevator construction sketch

Hoistway vertical section

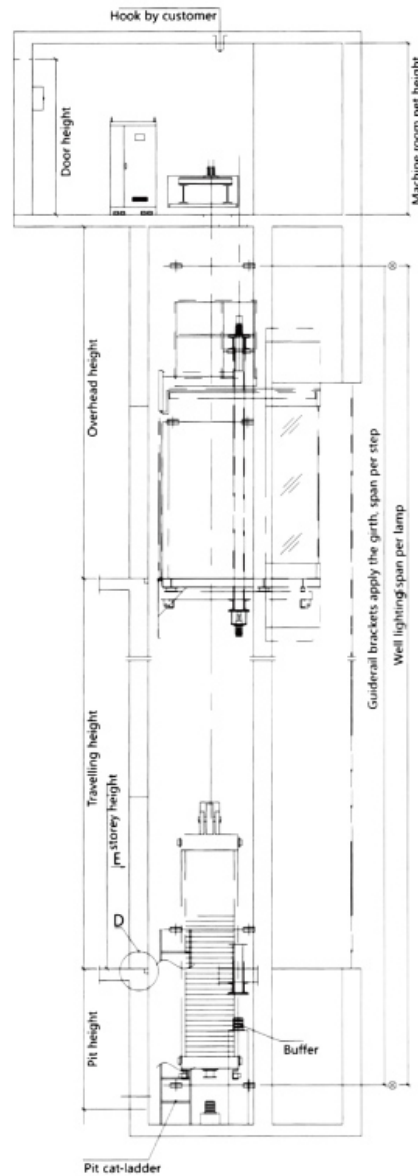

Machine room plan layout

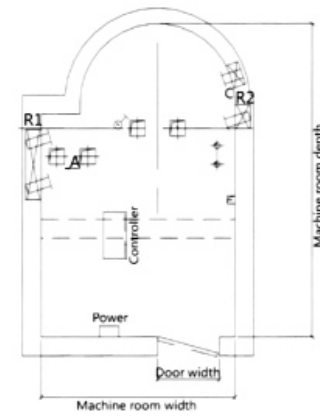

Hoistway plan layout

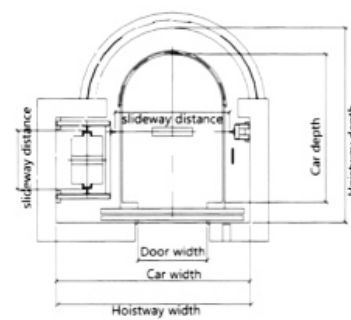

Hoistway vertical section

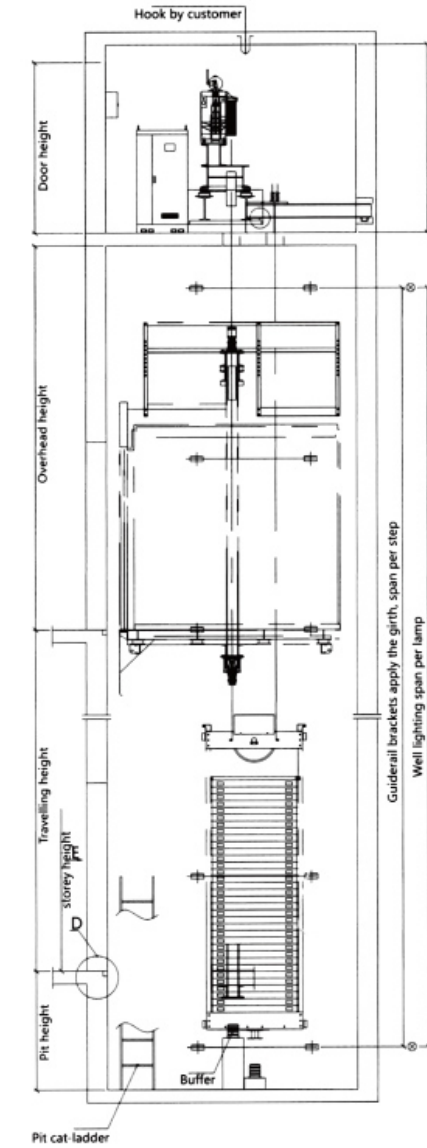

Machine room plan layout

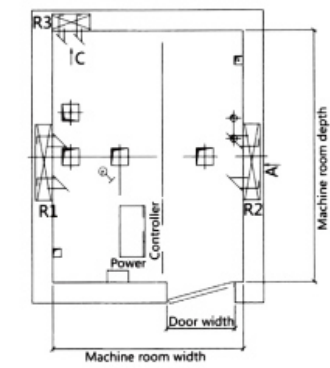

Hoistway plan layout

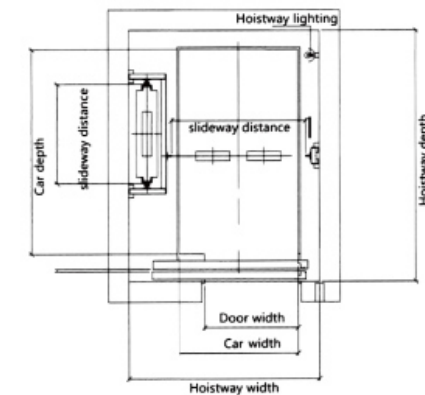

Observation elevator construction specifications

Persons	Rated capacity	Rated speed	Net size of car	Net size of door	Shaft size			Machine room size	
			C.W×C.D	2P Central opening	H.W×H.D	HR.H	PIT	MR.W×MR.D	MR.H
8	630	1.0	1100×1600	800×2100	2300×2200	4500	2000	2300×4000	2500
		1.5/1.75				4600	2000		
10	800	1.0	1200×1800	800×2100	2400×2400	4500	2000	2400×4000	2500
		1.5/1.75				4600	2000		
		2.0				4700	2000		
13	1000	1.0	1300×1900	900×2100	2500×2500	4500	2000	2500×4000	2500
		1.5/1.75				4600	2000		
		2.0				4700	2000		

The schematic Drawing of Aekson Sanyo work is for reference only

Hospital elevator construction specifications

Persons	Rated capacity	Rated speed	Net size of car	Net size of door	Shaft size			Machine room size	
			C.W×C.D	D.W×D.H	H.W×H.D	HR.H	PIT	MR.W×MR.D	MR.H
21	1600	1.0	1400×2400	1100×2100 2P telescopic opening	2300×2900	4500	1500	3000×4500	2500
		1.5/1.75					1600		
		2					1800		

The schematic Drawing of Aekson Sanyo work is for reference only

Perfect supply system

The enterprise pursues the objective of "being centered by clients". It establishes the perfect supply system. It can choose material nearby. It answers the clients as soon as possible. It offers prompt and convenient parts supply. It becomes the most powerful basic material guarantee in the service system. With coordination of the strong storage & delivery center, the customers can enjoy the more prompt and convenient service within the shortest time possible.

Considerate service

Professional repair & maintenance system

It regularly assigns repair and maintenance staff to test and maintain the elevators. It promptly finds the problems and remove any hidden danger in advance. It gives a full use of Web of Things technology. It fulfills organic linkage to elevator running condition test & alarm, emergency repair. It promises to arrive at site within 30 minutes. It provides vast clients with prompt and accurate repair & maintenance service.

24-hour customer service hotline

Sail intelligent elevator owns the powerful service team. They offers 24-hour all-weather safeguard for your passenger flow. Our repair & maintenance staff stress upon safe and practical properties with rapid response. They rush to the site as soon as possible. They go all out to provide you with effective long-term solution plans.

Long-distance monitor

Various repair & maintenance networks execute real-time monitor to running elevators through preset intellectual building system interface (i.e. long-distance monitor interface). If there is something wrong with elevator, it notifies after-sale staff to promptly solve the problem as soon as possible. It guarantees 365-day 24-hour safe & reliable elevator operation.

Specialized installation system

It persists in human-centered principle. It applies effective and precise customer management system and technical training system. It is equipped with professional installation team with rich experience. It regularly provides installation team with skill and safety training. It enhances their professional capabilities. It constructs an excellent installation team in elevator industry. It supplies all-round considerate service from ordering, booking to delivery and installation flows etc.

